

**VIDIKRON**

**VISION 50**  
MODEL

DLP™ PROJECTOR



<b>Warranty .....</b>	<b>5</b>
<b>Safety Precautions.....</b>	<b>8</b>
<b>Overview .....</b>	<b>9</b>
Features .....	9
Front / Top View .....	10
Rear / Bottom View .....	11
<b>Controls and Functions .....</b>	<b>13</b>
Control Panel.....	13
Connector Panel .....	14
Built-In Control Panel .....	14
Vidikron Logo .....	15
Remote Control.....	15
Control Panel / Remote Control Functions Compared .....	17
<b>Installation.....</b>	<b>19</b>
Remote Control.....	19
Installation Considerations.....	20
<b>Connections .....</b>	<b>25</b>
Connecting Video Inputs .....	25
Connecting a Computer (GBRHV).....	27
Connecting an HDMI™ Device .....	27
Connecting to AC Power .....	28
<b>Basic Operation .....</b>	<b>29</b>
Turning on the Power.....	29
Adjusting the Zoom, Focus and Lens Shift.....	29
Adjusting Projector Height or Projection Angle.....	29
Selecting Video Memory .....	30
Selecting an Aspect Ratio .....	30
Using the Menus.....	31
Selecting the Input Source .....	31
PIP / PBP Function.....	31
Turning off the Power .....	32
<b>On-Screen Display Menus .....</b>	<b>33</b>
Using the Menu .....	33
Main Menu .....	33
Picture Quality Adjustments .....	34
Image Options .....	36
Projector Status .....	39
Installation .....	40

## Table of Contents (continued)

Service.....	41
ISF Calibration .....	45
<b>Lamp Replacement .....</b>	<b>47</b>
<b>Troubleshooting .....</b>	<b>49</b>
<b>RS-232 Setup .....</b>	<b>51</b>
Connecting RS-232 to the Projector .....	51
RS-232C Control Codes.....	52
<b>Specifications .....</b>	<b>55</b>
<b>Dimensions .....</b>	<b>57</b>

# **TWO YEAR LIMITED WARRANTY**

## **For Projectors, Video Processors and Controllers**

Congratulations on your purchase of a Vidikron video product and welcome to the Vidikron family! With proper installation, setup and care, you should enjoy many years of unparalleled video performance.

This is a LIMITED WARRANTY as defined in the Magnuson-Moss Warranty Act. Please read it carefully and retain it with your other important documents.

### **WHAT IS COVERED UNDER THE TERMS OF THIS LIMITED WARRANTY:**

**SERVICE LABOR:** Vidikron will pay for service labor by a Vidikron Authorized Service Center when needed as a result of manufacturing defect for a period of two (2) years from the effective date of delivery to the end user (excluding the lamp).

**PARTS:** (Not including the lamp) Vidikron will provide new or rebuilt replacement parts for the parts that fail due to defects in materials or workmanship for a period of two (2) years from the effective date of delivery to the end user. Such replacement parts are then subsequently warranted for the remaining portion (if any) of the original warranty period.

**PROJECTOR LAMP:** Vidikron will pay for service labor by a Vidikron Authorized Service Center when needed as a result of a manufacturing defect for a period of six (6) months or 1000 hours, which ever comes first, from the effective date of delivery to the end user. In addition, Vidikron will provide a new or rebuilt replacement lamp for the lamp that fails due to defects in materials or workmanship for a period of six (6) months or 1000 hours, which ever comes first, from the effective date of delivery to the end user. Such replacement lamps are then subsequently warranted for the remaining portion (if any) of the original warranty period.

### **WHAT IS NOT COVERED UNDER THE TERMS OF THIS LIMITED WARRANTY:**

This Limited Warranty only covers failure due to defects in materials and workmanship that occur during normal use and does not cover normal maintenance. This Limited Warranty does not cover cabinets or any appearance items; failure resulting from accident, misuse, abuse, neglect, mishandling, misapplication, faulty or improper installation or setup adjustments; improper maintenance, alteration, improper use of any input signal; damage due to lightning or power line surges, spikes and brownouts; damage that occurs during shipping or transit; or damage that is attributed to acts of God. In the case of remote control units, damage resulting from leaking, old, damaged or improper batteries is also excluded from coverage under this Limited Warranty.

**CAUTION:** THIS LIMITED WARRANTY ONLY COVERS VIDIKRON PRODUCTS PURCHASED FROM VIDIKRON AUTHORIZED DEALERS. ALL OTHER PRODUCTS ARE SPECIFICALLY EXCLUDED FROM COVERAGE UNDER THIS LIMITED WARRANTY. MOREOVER, DAMAGE RESULTING DIRECTLY OR INDIRECTLY FROM IMPROPER INSTALLATION OR SETUP IS SPECIFICALLY EXCLUDED FROM COVERAGE UNDER THIS LIMITED WARRANTY.

## **RIGHTS, LIMITS AND EXCLUSIONS:**

Vidikron limits its obligations under any implied warranties under state laws to a period not to exceed the warranty period. There are no express warranties. Vidikron also excludes any obligation on its part for incidental or consequential damages related to the failure of this product to function properly. Some states do not allow limitations on how long an implied warranty lasts, and some states do not allow the exclusion or limitation of incidental or consequential damages. So the above limitations or exclusions may not apply to you. This warranty gives you specific legal rights, and you may also have other rights that vary from state to state.

## **EFFECTIVE WARRANTY DATE:**

This warranty begins on the effective date of delivery to the end user. For your convenience, keep the original bill of sale as evidence of the purchase date.

## **IMPORTANT: WARRANTY REGISTRATION:**

Please fill out and mail your warranty registration card. It is imperative that Vidikron knows how to reach you promptly if we should discover a safety problem or product update for which you must be notified.

## **CONTACT A VIDIKRON AUTHORIZED SERVICE CENTER TO OBTAIN SERVICE:**

Repairs made under the terms of this Limited Warranty covering your Vidikron video product will be performed at the location of the product, during usual working hours, providing location of product is within normal operating distance from a Vidikron Authorized Service Center. In some instances it may be necessary for the product to be returned to the Vidikron factory for repairs. If, solely in Vidikron's judgment, location of product to be repaired is beyond normal operating distance of the closest Vidikron Authorized Service Center, or the repair requires the unit be returned to the Vidikron factory, it is the owner's responsibility to arrange for shipment of the product for repair. These arrangements must be made through the selling Vidikron Dealer. If this is not possible, contact Vidikron directly for a Return Authorization number and shipping instructions. Vidikron will return product transportation prepaid in the United States, unless no product defect is discovered. In that instance, shipping costs will be the responsibility of the owner.

## **COPYRIGHT AND TRADEMARKS**

© Copyright 2005 Vidikron. This document contains proprietary information protected by copyright. All rights are reserved. No part of this manual may be reproduced by any mechanical, electronic or other means, in any form, without prior written permission of the manufacturer.

All trademarks and registered trademarks are the property of their respective owners.

---

**ADDITIONAL INFORMATION:**

To locate the name and address of the nearest Vidikron Authorized Service Center, or for additional information about this Limited Warranty, please call or write:

VIDIKRON  
Attn: Customer Service Department  
2900 Faber Street  
Union City, CA 94587  
Ph: (510) 324-5900  
Fax: (510) 324-5905  
Toll Free: (888) 4VIDIKRON

---

VIDIKRON PRODUCT INFORMATION

RETAIN THIS INFORMATION FOR YOUR RECORDS

---

Model Purchased

Date

---

Serial Number

---

Vidikron Authorized Dealer Name

---

Address

---

City

State/Province

Postal Code

---

Phone

Fax

## Safety Precautions

Thank you for your purchase of this quality Vidikron video projector! It has been designed to provide you with the quality of video that is expected in a home theater. For the best performance, please read this manual carefully as it is your guide through the menus and operation.

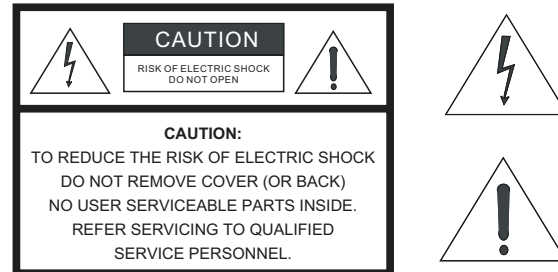

### WARNING

This symbol is intended to alert the user to the presence of uninsulated “dangerous voltage” within the product’s enclosure that may be of sufficient magnitude to constitute a risk of electric shock.

This symbol is intended to alert the user to the presence of important operating and maintenance (servicing) instructions in the literature accompanying the appliance.

This equipment has been tested and found to comply with the limits for a Class B digital device, pursuant to Part 15 of the FCC Rules. These limits are designed to provide reasonable protection against harmful interference in a residential installation.

1. Read these instructions.
2. Keep these instructions.
3. Heed all warnings.
4. Do not use this projector near water, outdoors or otherwise exposed to the elements.
5. Clean only with a dry cloth.
6. Do not block any ventilation openings.
7. Do not install near any heat sources such as radiators, heat registers, stoves, or other apparatus (including amplifiers) that produce heat.
8. Do not defeat the safety feature of the polarized or grounding type plug. A polarized type plug has two blades with one wider than the other. A grounding type plug has two blades and a third grounding prong. The third prong is provided for your safety. If the provided plug does not fit into your outlet, consult an electrician for the replacement of the obsolete outlet.
9. Do not connect the RJ-11 RS-232 jack to a telephone line connection.
10. The 12V trigger only outputs DC 12V signal for triggering. Do not connect to any other power input or output. This could cause damage to this unit.
11. Only use accessories specified by Vidikron.
12. Keep the packing material in case the projector should ever need to be shipped.
13. Unplug this projector during lightning storms or when it will not be used for an extended period of time.
14. The lamp becomes extremely hot during operation. Allow the projector to cool down for approximately 45 minutes prior to removing the lamp assembly for replacement. Do not operate lamps beyond the rated lamp life. Excessive operation of lamps beyond rated life could cause them to explode in rare occasions.
15. Refer all servicing to qualified service personnel. Servicing is required when the projector has been damaged in any way, objects have fallen or spilled into the projector, the projector has been exposed to rain or moisture, does not operate normally, or has been dropped.



---

### Features

- **Native 16:9 Aspect Ratio DMD 1280 x 720p**
- **High Contrast and Picture Quality**  
12-degree mirrors with dark metal process.
- **High Dynamic Range and Rich Gray-scale**  
8-segment, 5x color wheel with wide color space.
- **TIR (Total Internal Reflection) Prism**  
High-performance light engine with Cat's Eye optics.
- **Wide Variety of Inputs**  
Support for various video formats, including Composite, S-Video, Component, DTV Y/P<sub>B</sub>/P<sub>R</sub>, DTV RGB HD and Computer signals. The HDTV input (DTV Y/P<sub>B</sub>/P<sub>R</sub> and DTV RGB) is via RGB BNC connectors, providing the least amount of signal degradation caused by longer cable runs.
- **HDTV Ready**  
480p, 1080i and 720p (576p PAL Version) formats are all compatible with this unit (via an external DTV decoder, not provided).
- **De-interlacing with 3:2 Pull-down**  
Using Vidikron's proprietary De-interlacing technology, this projector provides exceptional scaling and film-to-video (3:2 pulldown) conversion for the most artifact-free images possible.
- **PIP/ PBP function**  
Picture in Picture/Picture by Picture functions allow you to display two inputs on the screen at the same time.
- **ISF Calibration**  
This product includes ISF day and night mode settings as established by the Imaging Science Foundation. These standards provide for superior image quality and assure the user that restoration to preset values for both day and night viewing is accomplished by just the press of a button, should the projector's settings or calibrations be inadvertently disturbed.

---

## Front / Top View

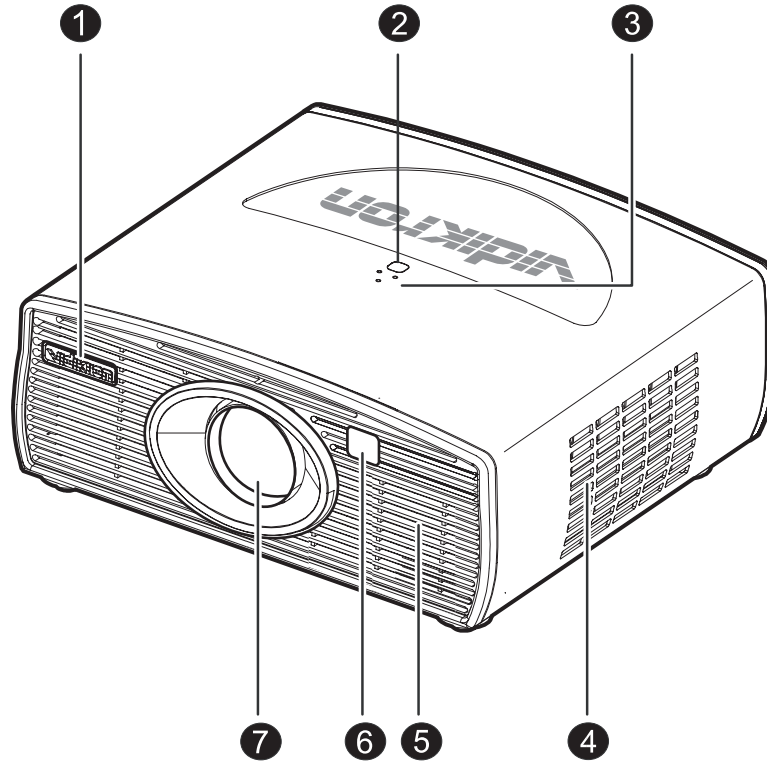

- |   |                           |
|---|---------------------------|
| <b>1. Vidikron Logo</b><br>Can be rotated to match floor or ceiling installation. See "Vidikron Logo" on page 15. | <b>4. Intake Vent</b>     |
| <b>2. Top IR Sensor</b>   | <b>5. Exhaust Vent</b>    |
| <b>3. Status LEDs</b><br>See "Control Panel" on page 13.  | <b>6. Front IR Sensor</b> |
|   | <b>7. Projection Lens</b> |

**Rear / Bottom View**

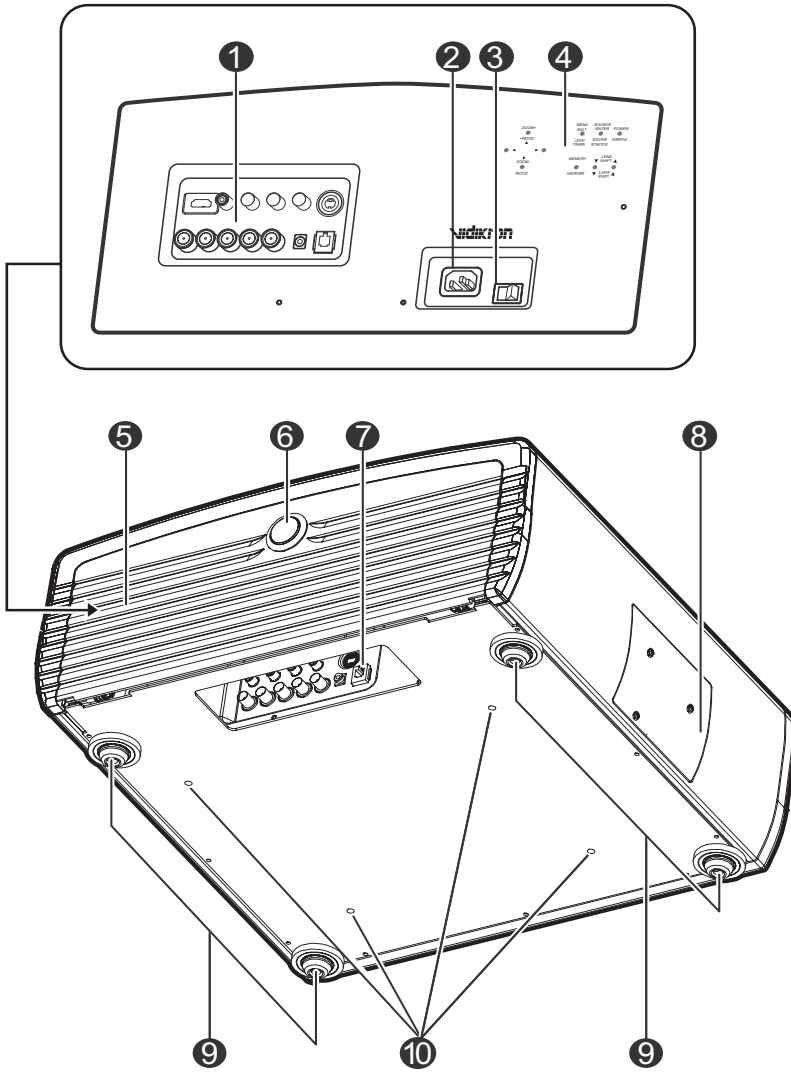

- |   |   |
|---|---|
| <p><b>1. Connector Panel</b><br/>See "Connector Panel" on page 14.</p> <p><b>2. AC Power IN Socket</b></p> <p><b>3. AC Power Switch</b></p> <p><b>4. Built-in Control Panel</b><br/>See "Built-in Control Panel" on page 14.</p> <p><b>5. Cable Access Door</b><br/>Open to access connectors.<br/>See "Connector Panel" on page 14.</p> <p><b>6. Door Release Button</b></p> | <p><b>7. Cable Opening</b><br/>Pass cables through this opening.</p> <p><b>8. Lamp Module Cover</b><br/>Remove this cover when replacing the lamp. See "Lamp Replacement" on page 47.</p> <p><b>9. Front / Rear Adjusters</b><br/>Adjusts the height or projection angle.</p> <p><b>10. Ceiling Mount Holes</b><br/>The connecting holes for the ceiling mount bracket.</p> |
|---|---|

This page is intentionally left blank.

## Control Panel

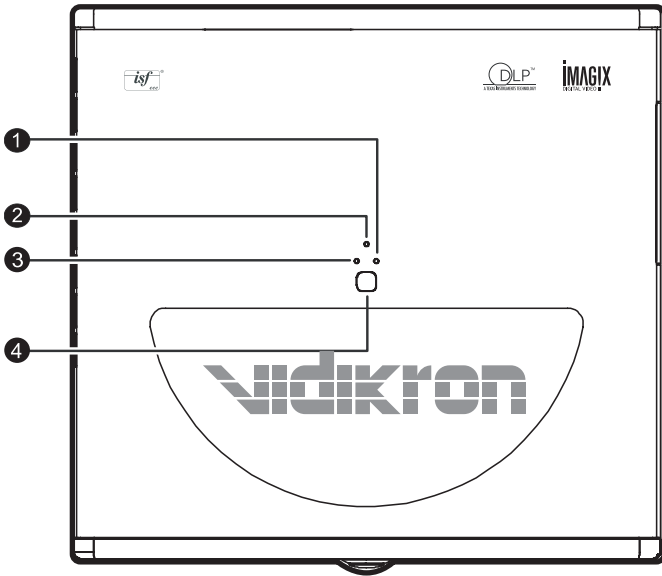

### 1. LAMP LED

Indicates the status of the lamp

- Red when the lamp has exceeded its usage life or developed a problem. Please contact your Vidikron Dealer for assistance.
- Flashing Red when the fans are not working or the lamp cover is open. Please contact your Vidikron Dealer for assistance.

### 3. TEMP LED

Indicates the status of the fans and internal temperature

- Red when the internal temperature is too high. Please contact your Vidikron Dealer for assistance.
- Flashing Red when the fans are not working or the lamp cover is open. Please contact your Vidikron Dealer for assistance.

### 2. POWER LED

Indicates the status of the power

- Orange when the AC power cord is plugged into a wall outlet (standby mode). Once in standby mode, you can turn on the projector by pressing the ON button on the remote control.
- Green when the power is turned on (operational mode).
- Flashing Orange for the first 45 seconds after power-up indicating that the lamp is warming up.
- Flashing Green for 110 seconds after the projector was powered off indicating that the lamp is cooling down.

### 4. TOP IR SENSOR

## Connector Panel

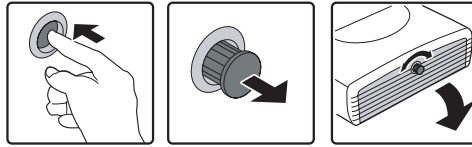

To access the connector panel, press the door release button so it pops out. Turn the knob clockwise or counter-clockwise and pull firmly on it to open the door.

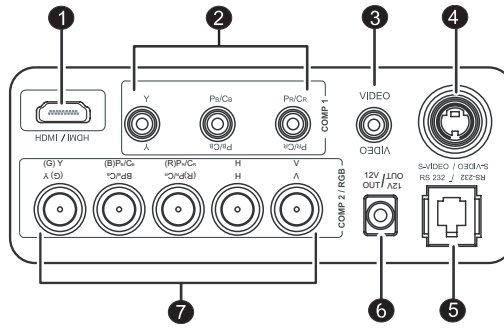

- 1. HDMI (High-Definition Multimedia Interface) Input**  
Digital video signal input
- 2. Component (RCA Jacks)**  
480i Component (Y/CB/CR) video signal input
- 3. Video (RCA Jack)**  
Composite video signal input
- 4. S-Video (mini DIN 4-pin) Y/C (S-video) signal input**
- 5. RS-232C (RJ-11 Jack)**  
RS-232C control signal input (refer to page 51 for details)
- 6. 12v Trigger (mini jack, diameter 5.5 mm outside, 2.5 mm inside)**  
+12V output, active when the projector is turned on
- 7. RGB/ HDTV (BNC) or Progressive Scan DVD players**  
DTV Y/Pb/Pr or DTV RGB video signal input

## Built-In Control Panel

To control the projector when signals from a remote control cannot reach it, use the built-in keypad next to the connector panel.

Because the built-in keypad has fewer keys than the remote keypad, certain projector functions are accessible only through the menu system rather than via a direct key.

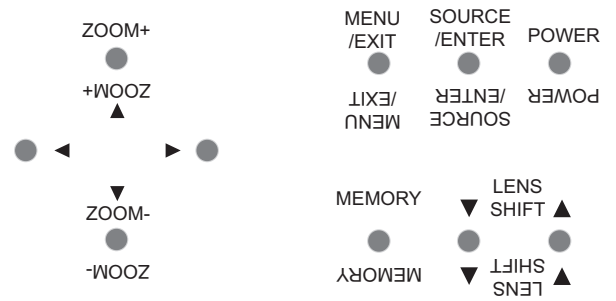

The Vidikron logo on the front of the projector can be rotated to match a floor or ceiling installation. To rotate the logo, grip it at the sides, pull it away from the projector and rotate it 180 degrees.

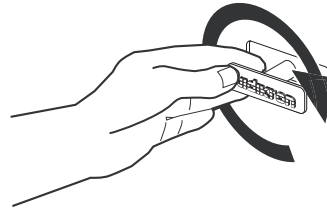

## Vidikron Logo

## Remote Control

**Arrow (▲, ◀, ▼, ▶)**  
Use to select the menu or to make various adjustments.

**ENTER**  
Enter the setting of items in the menu.

**EXIT**  
Exit and save the setting(s) of items in the menu.

**MENU**  
Turns the on-screen display menu on or off.

**LIGHT**  
Press to turn on the remote control back light.

**OFF**  
Press to turn off the projector.

**ON**  
Press to turn on the projector.

**COMP1 (Component 1)**  
Component Y/Cb/Cr input.

**S-VID (S-Video)**  
S-Video signal input.

**VIDEO**  
Composite video signal input.

**COMP2 (Component 2)**  
DTV Y/Pb/Pr signal input.

**RGB HD**  
DTV RGBHV signal input.

**HDMI**  
High-Definition Multimedia Input.

**VAC**  
Adjusts the motorized aperture lens iris. (See "Aperture Control" on page 43.)

**Buttons on the remote:** OFF, ON, COMP 1, S-VID, VIDEO, COMP 2, RGB HD, HDMI, ANA, 4X3, L-BOX, I-WIDE, CINEMA, C-FILL, MEM1, ISF NT, ISF DAY, DEF, ENTER, EXIT, MENU, 1-9, 0, PIP, PIP+, ACTIVE, PBP, PIP-, VAC, LENS SHIFT, FOCUS, ZOOM, LIGHT.

## Remote Control (continued)

**MEM1, ISF NT (Night), ISF DAY, DEF**  
 Recall video memory sequentially. See "Selecting Video Memory" on page 30.

**0 - 9**  
 Press to type in menu passcodes.

**PIP (Picture in Picture)** Enable the PIP function. Use the arrow buttons to adjust the position of the PIP window. See "PIP / PBP Function" on page 31.

**PIP+**  
 Enlarge the size of PIP window.

**ACTIVE**  
 Switch to the active window in PIP display mode.

**PBP (Picture by Picture)**  
 Enable the PBP function.

**PIP-**  
 Shrink the size of the PIP window.

**ANA (Anamorphic)**  
 For 16:9 DVDs.

**4X3 (Standard 4:3)**  
 The input signal will be scaled to fit 4:3 display mode in the center of the screen.

**L-BOX (Letterbox)**  
 Image in letterbox format is enlarged to fit 16:9 full screen display and the upper/ lower portions are "blanked off."

**I-WIDE (IntelliWide)**  
 4:3 image is enlarged NON-linearly in horizontal direction to fit 16:9 full screen display.

**CINEMA**  
 Image in Letterbox mode is enlarged to a 16x9 image and the upper and lower portions are compressed.

**C-FILL (Cinema Fill)**  
 A 2.35 image is stretched vertically in both directions to fill a 16:9 image.

**LENS SHIFT**  
 Shift the lens vertically.

**FOCUS**  
 Adjust the focus of the image.

**ZOOM**  
 Adjust the size of the image.





The following illustration shows remote control buttons that are duplicated on the control panel. Some of the functions such as power ON/OFF are combined in one button on the control panel, however, the function is the same. This user manual describes the functions based on the remote control.

## Control Panel / Remote Control Functions Compared

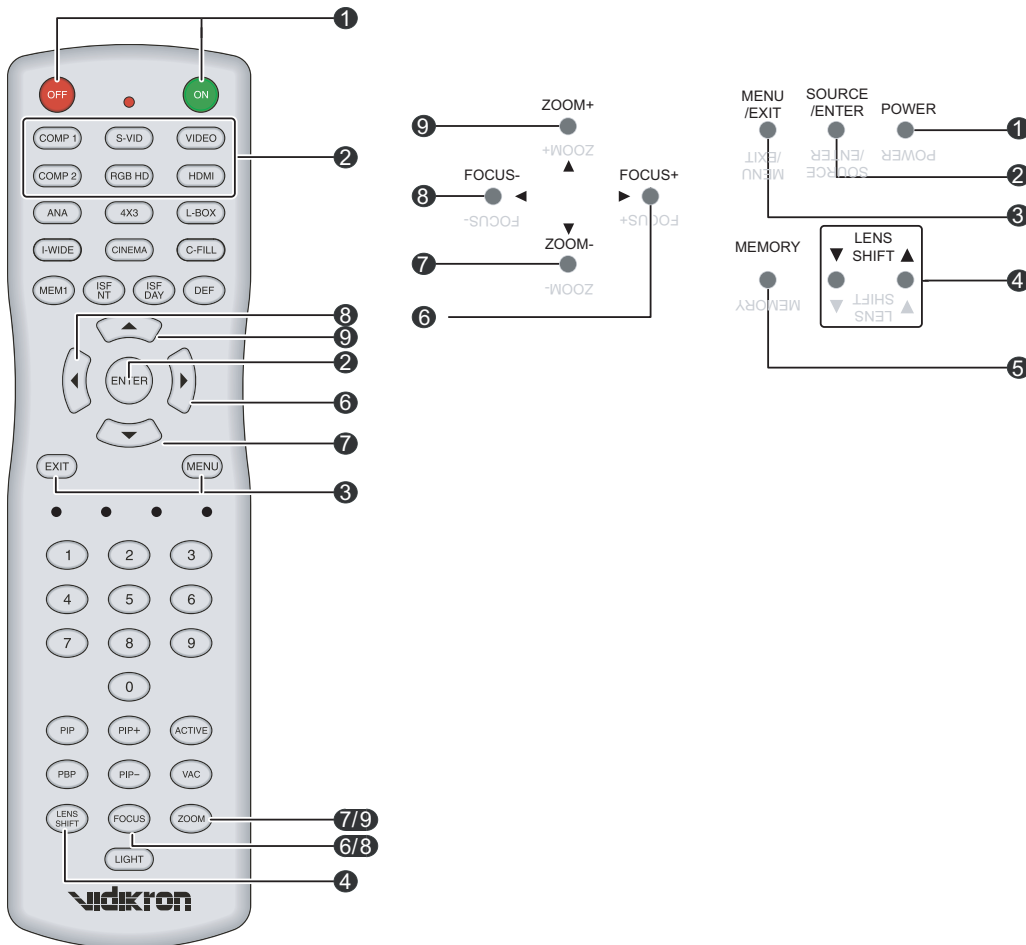

This page is intentionally left blank.

To remove the battery cover, press in then pull up the small plastic clip holding the cover in place. Install the two AAA batteries with the correct polarity and then replace the cover.

## Remote Control

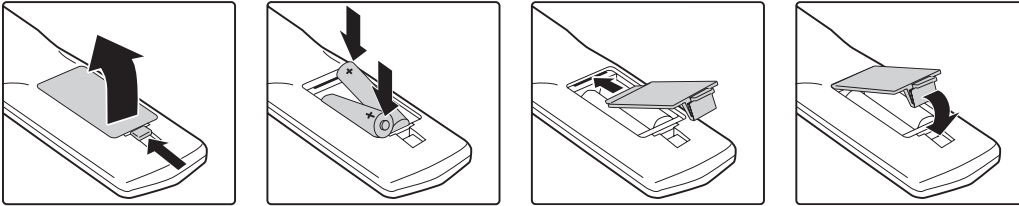

### **About the Batteries**

- Make sure that the battery polarities are correct when installing the batteries.
- Do not mix an old battery with a new one or different types of batteries.
- If you will not use the remote control for a long time, remove the batteries to avoid damage from battery leakage.

### **About the Remote Control**

- Make sure that there is nothing obstructing the infrared beam between the remote control and the IR receiver on the projector.
- The usable range is up to 8 meters (26.25 feet) within a 45-degree horizontal angle and a 15-degree vertical angle.
- If the effective range of the remote control decreases, or it stops working, replace the batteries with new ones.
- The remote control may fail to operate if the infrared remote sensor is exposed to bright sunlight or fluorescent lighting.
- Ambient conditions may impede the operation of the remote control. If this happens, point the remote control at the projector, and repeat the operation.
- The Ø icon appears on the screen when a button for an unavailable function is pressed.

## Installation Considerations

Proper installation of your projector will ensure the quality of your display. Whether you are installing a projector temporarily or permanently, you should take the following into account to ensure your projector performs optimally.

**Installation Type** ➤ Choose the installation type that best suits your needs: front or rear screen, floor mount or inverted mount.

### Front Screen, Floor Mount Installation

Advantages	Considerations
<ul style="list-style-type: none"> <li>• Easy to set up</li> <li>• Can be moved or changed quickly</li> <li>• Easy to access</li> </ul>	<ul style="list-style-type: none"> <li>• Shares floor space with audience</li> </ul>

### Front Screen, Inverted Mount (ceiling) Installation

Advantages	Considerations
<ul style="list-style-type: none"> <li>• Does not take up audience space</li> <li>• Projector is unobtrusive</li> <li>• Projector cannot be accidentally moved</li> </ul>	<ul style="list-style-type: none"> <li>• Installation is more permanent</li> <li>• It is more difficult to access the projector</li> </ul>

### Rear Screen, Floor Mount Installation

Advantages	Considerations
<ul style="list-style-type: none"> <li>• Projector is completely hidden</li> <li>• Projector is easily accessed</li> <li>• Usually good ambient light rejection</li> </ul>	<ul style="list-style-type: none"> <li>• Requires separate room</li> <li>• Installation cost is usually higher</li> </ul>

### Rear Screen, Inverted Mount (ceiling) Installation

Advantages	Considerations
<ul style="list-style-type: none"> <li>• Projector is completely hidden</li> <li>• Usually good ambient light rejection</li> </ul>	<ul style="list-style-type: none"> <li>• Requires separate room</li> <li>• Installation cost is usually higher</li> </ul>

### Rear Screen, Floor Mount with Mirror

Advantages	Considerations
<ul style="list-style-type: none"> <li>• Projector is completely hidden</li> <li>• Usually good ambient light rejection</li> <li>• Requires less space behind screen than other rear screen installations</li> </ul>	<ul style="list-style-type: none"> <li>• Requires separate room</li> <li>• Installation cost is usually higher</li> </ul>

**Screen Type and Size** ➤ **Front Screen Installations**

In front screen installations the projector and audience are positioned in front of the screen, which can be flat or curved.

Flat screens are recommended with this projector. They offer a gain of about 1 with a viewing angle just less than 180°. This type of screen reflects incident light equally in all directions so the audience can see the display from various angles.

Curved screens have a gain greater than 1 with a viewing angle much less than 180°. This type of screen does not reflect incident light equally in all directions; instead, it is concentrated in a viewing cone. The audience sitting within the viewing cone area sees a brighter image than those sitting just outside this area. Vidikron generally does not recommend use of curved screens due to excessive brightness and uncorrectable geometrical distortion.

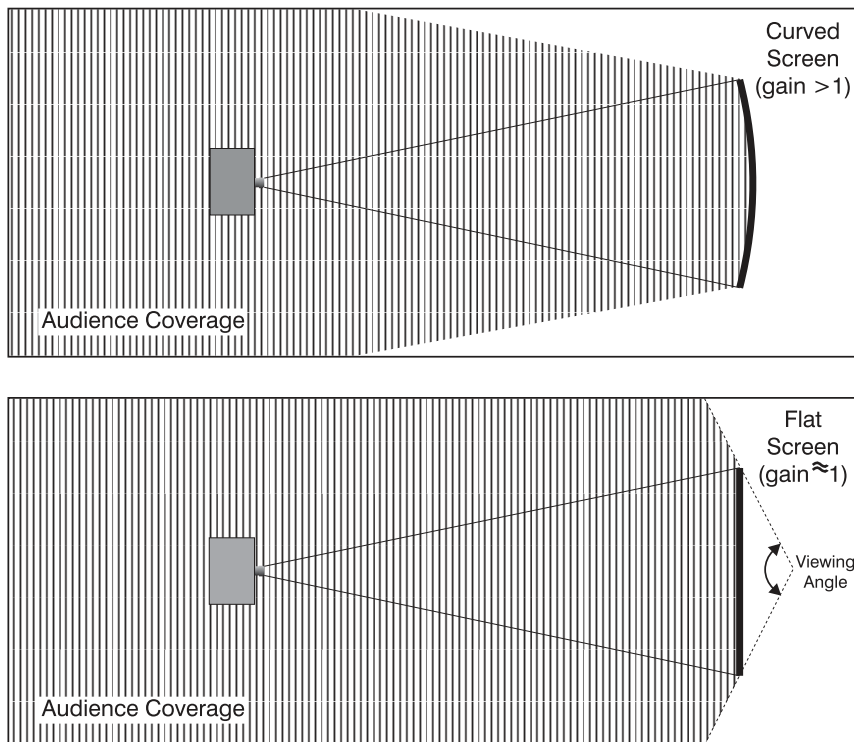

### Rear screen installations

There are two basic types of rear screens: diffused and optical.

A diffusion screen has a surface that spreads the light striking it. Purely diffused screens have a gain of less than 1. The main advantage of the diffused screen is its wide viewing angle, similar to that of a flat screen for front screen projection. This type of screen is suitable when a wide viewing angle is required but there is low ambient room lighting.

Optical screens take light from the projector and redirect it to increase the light intensity at the front of the screen. This reduces it in other areas. A viewing cone similar to that of a curved, front-screen installation is created. This type of screen is better suited for brightly lit rooms where the audience is situated within the viewing cone.

### Screen size

Choose a screen size that is appropriate for your lens and application. The size of the room and viewing distance are the defining factors; a rule of thumb is that the primary viewing distance be 1.5 times the screen width.

To fill a screen with an image, the aspect ratio of the screen should be equal to the aspect ratio of the image (expressed as the ratio of its width to its height). Standard video from a VCR has a 4:3 or 1.33:1 aspect ratio. For example, to display a VCR output with a 4:3 aspect ratio onto a 10-foot (3.05-meter) high screen, the width of the screen must be at least 13.3 feet (4 meters).

**Ambient Light** ➤ In general, minimize or eliminate light sources directed at the screen. Contrast ratio in your images will be noticeably reduced if light directly strikes the screen, such as when a shaft of light from a window or floodlight falls on the image. Images may then appear washed out and less vibrant.

**Other Considerations** ➤ Other considerations and tips that can help improve your installation:

- Keep the ambient temperature constant and below 35°C (95°F). Keep the projector away from heating and/or air conditioning vents. Changes in temperature may cause drifts in the projector circuitry, which may affect performance.
- Keep the projector away from devices that radiate electromagnetic energy such as motors and transformers. Common sources of these include slide projectors, speakers, power amplifiers and elevators.

**Throw Distance** ➤ Throw distance is the distance measured from your projector's lens to the screen. This is an important calculation in any projector installation as it determines whether or not you have enough room to install your projector with a desired screen size and if your image will be of the right size for your screen.

You can quickly estimate the throw distance by taking the width of the screen and multiplying it by the lens throw ratio. (The Model 50 has a lens throw ratio of between 1.82 and 2.42.)

**Estimating Throw Distance**

$$\text{Throw Distance (TD)} = \text{Screen Width (w)} \times \text{Lens Throw Ratio}$$

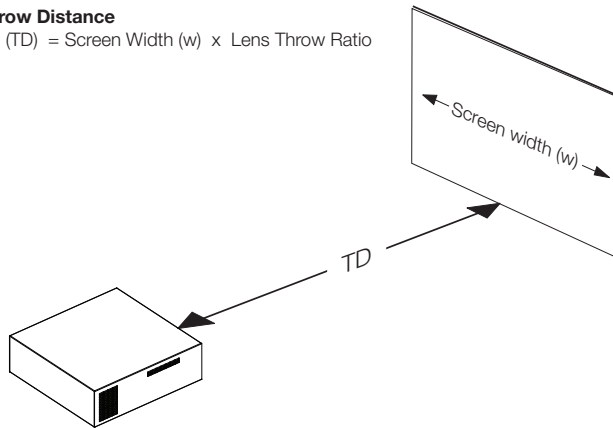

The result of this calculation tells you roughly how far back the projector should be positioned from the screen in order to project a focused image large enough to fill the screen.

For example, with an 8-foot (96-inch) wide screen (the maximum recommended screen width for this projector), the Model 50 has a throw distance range of between 174.72 inches (4.44 meters) and 232.32 inches (5.90 meters).

Proper placement of the projector relative to the screen will yield a rectangular, perfectly-centered image that completely fills the screen.

### ◀ **Vertical and Horizontal Position**

Ideally, the projector should be positioned perpendicular to the screen and in such a way that the lens center is aligned with either the top or bottom edge of the screen area, and centered horizontally.

The top of the projected image is even with the lens center when the projector is inverted (ceiling-mounted). Likewise, the bottom of the projected image is aligned with the lens center when the projector is upright (as in a floor installation).

#### **Ceiling Installation**

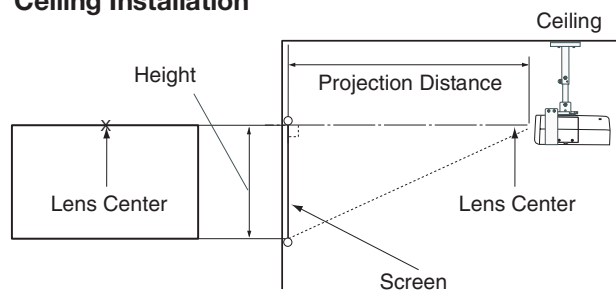

#### **Floor Installation**

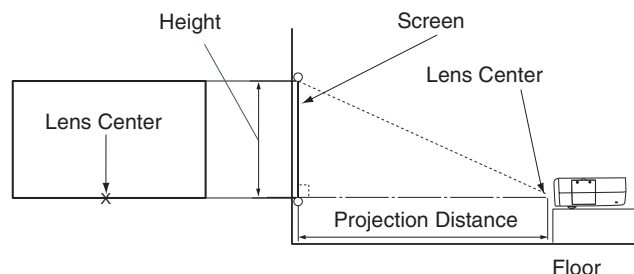

If it is not possible to align the projector and screen as shown above, you can tilt the projector at a slight angle. In a ceiling installation, you do this by adjusting the ceiling mount. For a floor installation, turn the four adjustable feet on the bottom of the projector to adjust the projector height and/or projection angle.

### ◀ **Adjusting the Projection Angle**

If you do this, you may need to make keystone adjustments or vertically shift the image using the on-screen display (OSD) controls, to compensate. For detailed instructions, refer to *On-Screen Display Menus*, later in this manual.

**Mounting** ➤ There are several methods for mounting the projector. Depending on your chosen installation, one method may be more suitable than another. In typical front and rear screen installations the projector can be mounted to a secure and level surface, such as a table or cart. Carts are useful when moving a projector during a presentation or from site to site. If possible, lock the wheels when it's in position to prevent it from being moved during a presentation.

**CEILING MOUNT**—The projector can also be inverted and suspended from the ceiling using a specially designed ceiling mount fixture. This type of mounting is recommended for fixed installations and for those that want the projector out of sight or have a limited space for projector and audience.

**Use only the Vidikron-approved ceiling mount kit designed for your projector.**

**Folded Optics** ➤ In rear screen applications where space behind the projector is limited, a mirror may be used to fold the optical path, as shown below. The position of the projector and mirror must be accurately set. If you are considering this type of installation, contact your dealer for assistance.

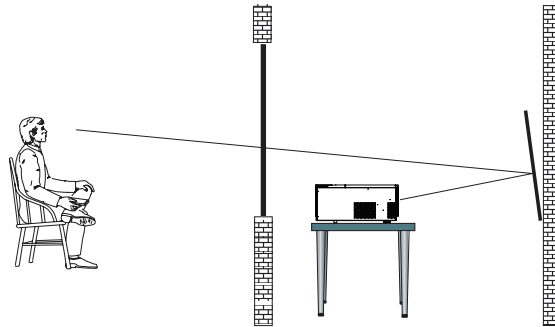



When connecting your equipment, make sure to:

1. Turn off all equipment before making any connections.
2. Use the correct signal cables for each source.
3. Ensure the cables are firmly connected.

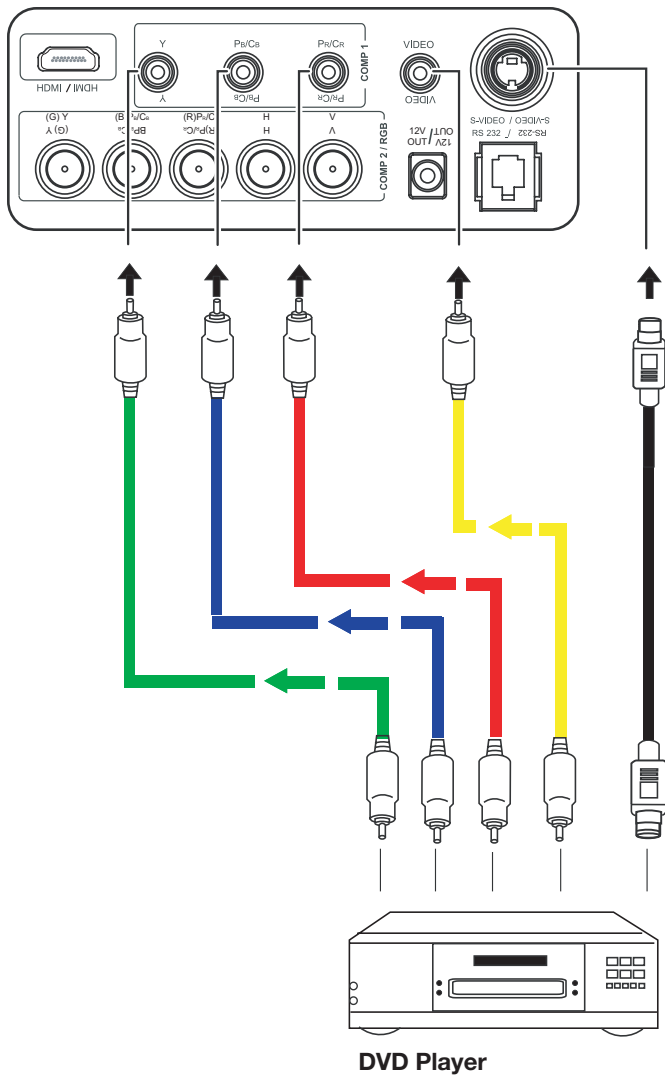

## Connecting Video Inputs

◀ **Video / S-Video / Component (Interlaced Video)**

The RGB BNC input (labeled **COMP 2 / RGB**) supports two kinds of HDTV formats: progressive component (DTV Y/P<sub>B</sub>/P<sub>R</sub>) and DTV RGB. The projector automatically detects the resolution.

**Progressive Component** ➤  
(DTV Y/P<sub>B</sub>/P<sub>R</sub>)

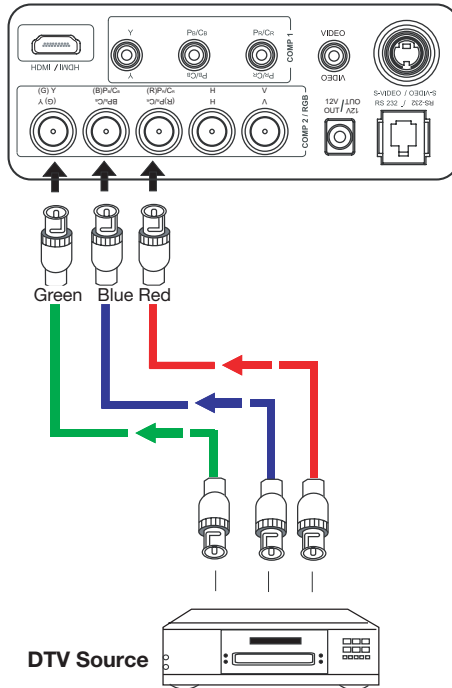

**RGBHV (DTV RGB)** ➤

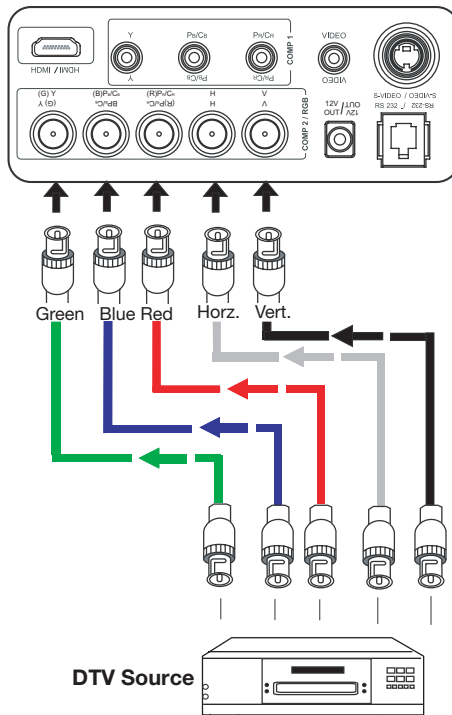

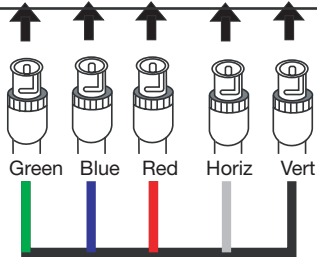
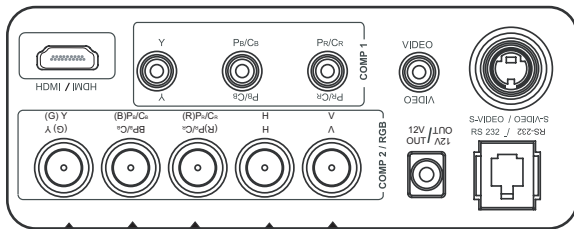

The projector supports the following computer resolutions: 1024x768, 800x600 and 640x480.

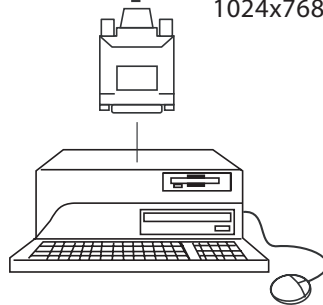

**PC or Notebook**  
(PC, RGB, Analog, HD Component, Progressive DVD)

## Connecting a Computer (GBRHV)

Use an HDMI (High-Definition Multimedia Interface) cable to connect the projector to an HDMI device.

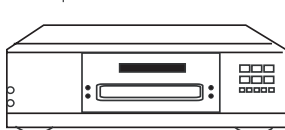
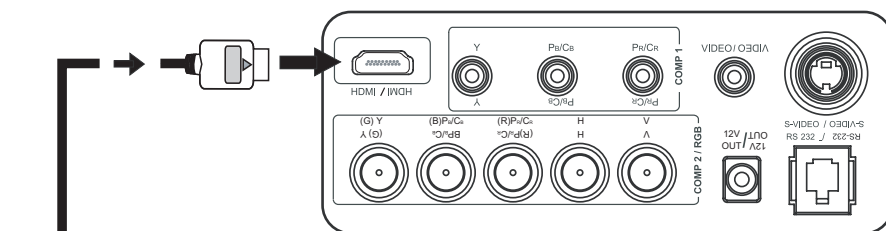

**HDMI Source**  
(DVD player or HD tuner with HDMI or DVI out)

## Connecting an HDMI™ Device

---

## Connecting to AC Power

The Vision Model 50 ships with various types of AC power cords. Choose the one that is appropriate to your locale.

Plug the female end of the power cord into the AC receptacle on the rear of the projector (AC 100V ~ 240V). Then, connect the other end to your AC power source.

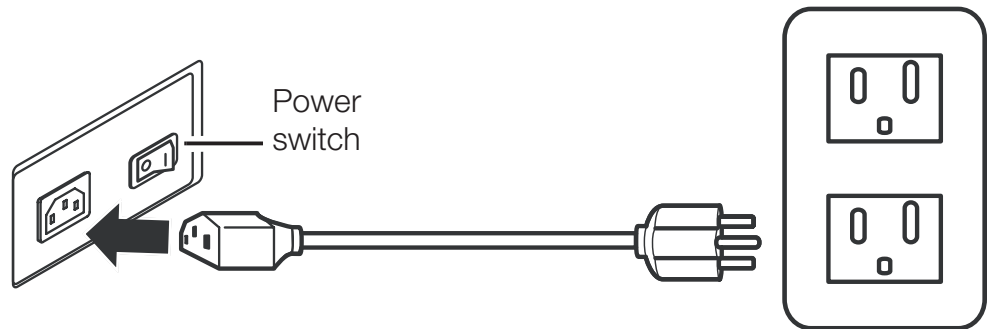

## Basic Operation

- Turn on the main power switch on the rear of the projector. The POWER LED will light orange.
- Press the ON button on the remote control to turn on the projector. The POWER LED flashes orange during the warm up period, then lights solid green.
- "Searching..." appears on the screen before the projector identifies the input signal, and remains there until a valid signal is detected.
- If an incompatible input signal exceeds the range of the projector, a "No signal supported" message appears on the screen. This message remains on the screen until you change the input signal.

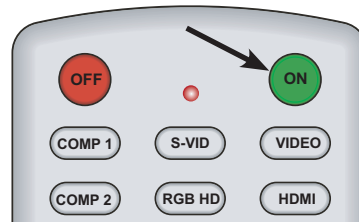

### Turning on the Power

- Press **ZOOM** and the arrow buttons (◀/▶) to adjust the projected image size.
- Press **FOCUS** and the arrow buttons (◀/▶) to focus the image.
- Press **LENS SHIFT** and the arrow buttons (▲/▼) to adjust the lens vertically.

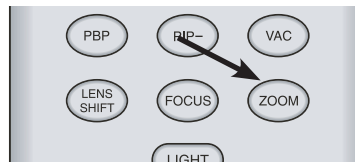

### Adjusting the Zoom, Focus and Lens Shift

- To adjust the projector height or projection angle, or to compensate for a mounting surface that isn't level, turn the four adjustable feet on the bottom of the projector.

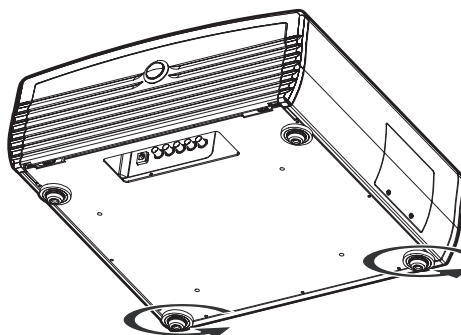

### Adjusting Projector Height or Projection Angle

## Selecting Video Memory

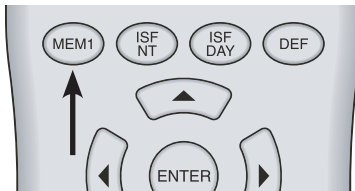

- Press **MEM1** to recall custom memory settings.
- Press **ISF NT (Night)** to recall ISF Night settings.
- Press **ISF DAY** to recall ISF Day settings.

*NOTE: ISF settings must be calibrated and stored by a certified ISF calibrator. For more information, please go to [www.imagingscience.com](http://www.imagingscience.com).*

- Press **DEF (Default)** to restore factory settings for the current source. An on-screen confirmation message appears. Press **DEF** again to confirm.

## Selecting an Aspect Ratio

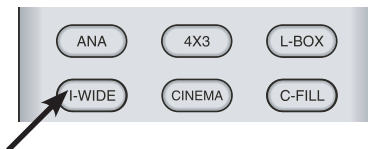

Select an aspect ratio that suits the format of the video signal. The following aspect ratios are available.

- **ANA (Anamorphic):** A 4:3 image is stretched horizontally to fit a 16:9 screen. This setting is for 16:9 DVDs and HDTV programs.
- **4 X 3 (Standard 4:3):** The input signal is scaled to fit a 4:3 display mode in the center of the screen.
- **L-BOX (Letterbox):** An image in letterbox format is enlarged to fit a 16:9 full screen display; the upper and lower portions are compressed.
- **I-WIDE (IntelliWide):** This setting transforms a 4x3 image to a 16x9 image.
- **CINEMA:** The image in the Letterbox mode is enlarged to a 16x9 image and the upper and lower portions are compressed.
- **C-FILL (Cinema Fill):** A 2.35 image is stretched vertically in both directions to fill a 16:9 image.

- Press **MENU** to open or close the on-screen menu.
- Use the arrow buttons (**▲**, **◀**, **▼**, **▶**) to select menu items or make adjustments.
- Press **ENTER** or **▶** to enter the setting of items in the menu, or press **EXIT** to leave and save the setting of items in the menu.

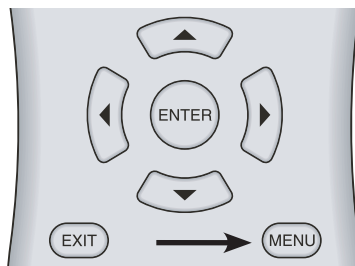

## Using the Menus

For more information on settings, See “On-Screen Display Menus” on page 33.

- When you turn on the projector, it searches for the input source you selected last time.
- You may select the input source directly on the remote control.

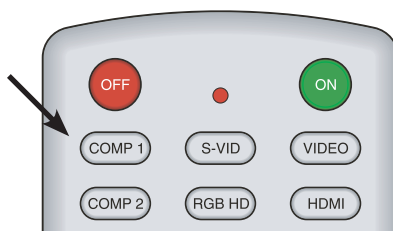

## Selecting the Input Source

- For PIP (Picture In Picture) and PBP (Picture By Picture) purposes, there are two groups of inputs separated by their display modes:

Video group: Video, S-Video and Component Y/C<sub>B</sub>/C<sub>R</sub> inputs.

Graphic (HD) group: HDMI and RGB/Component HD inputs.

- PIP / PBP shows one input from the Graphic group within or beside one input from the Video group.
- Press **PBP** to enable the PBP function. Press **PBP** again to switch the screens left to right. Press **PBP** again to turn PBP off.
- Press **ACTIVE** to switch to the active window. You can only change the input signal settings in the active window.
- Press **PIP** to enable the PIP function. Press PIP again to switch the main window. Press PIP again to turn PIP off.
- Press **PIP+** or **PIP-** to adjust the size of the PIP window.
- Adjust the position of the PIP window with the arrow buttons (**▲**, **◀**, **▼**, **▶**).

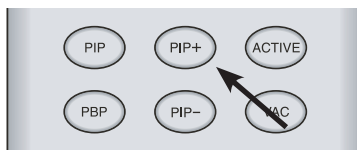

## PIP / PBP Function

## Turning off the Power

- Press **OFF** to turn off the projector.
- The **POWER** LED will blink green and the fans will speed up for a quick cool-down. The projector will not respond to any command for 90 seconds.
- The **POWER** LED will light solid orange once the cooling down cycle has completed.
- The fans will run for three minutes to cool.
- You can turn the projector back on after approximately two minutes.

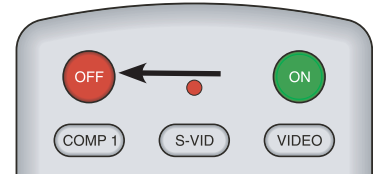



# On-Screen Display Menus

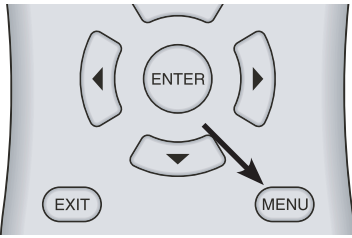

This unit is equipped with an on-screen display (OSD) menu for making adjustments and changing settings. There are five menu languages; see the Language setting under “Installation” on page 40.

## Using the Menu

- Press **MENU** to turn on/off the OSD menu.  
*NOTE: If the Main Menu is displayed, you can also press **EXIT** to turn it off.*
- Use the arrow buttons (**▲**, **◀**, **▼**, **▶**) to select items in the menu or to make various adjustments.
- Press **ENTER** to select an item to change, or press **EXIT** to return to the previous menu.

When the **MENU** button is pressed, the Main Menu (shown below) appears on the screen. Use the **▲** or **▼** button to move to an item, then press **ENTER** to select it. The menus are described more fully in the following sections.



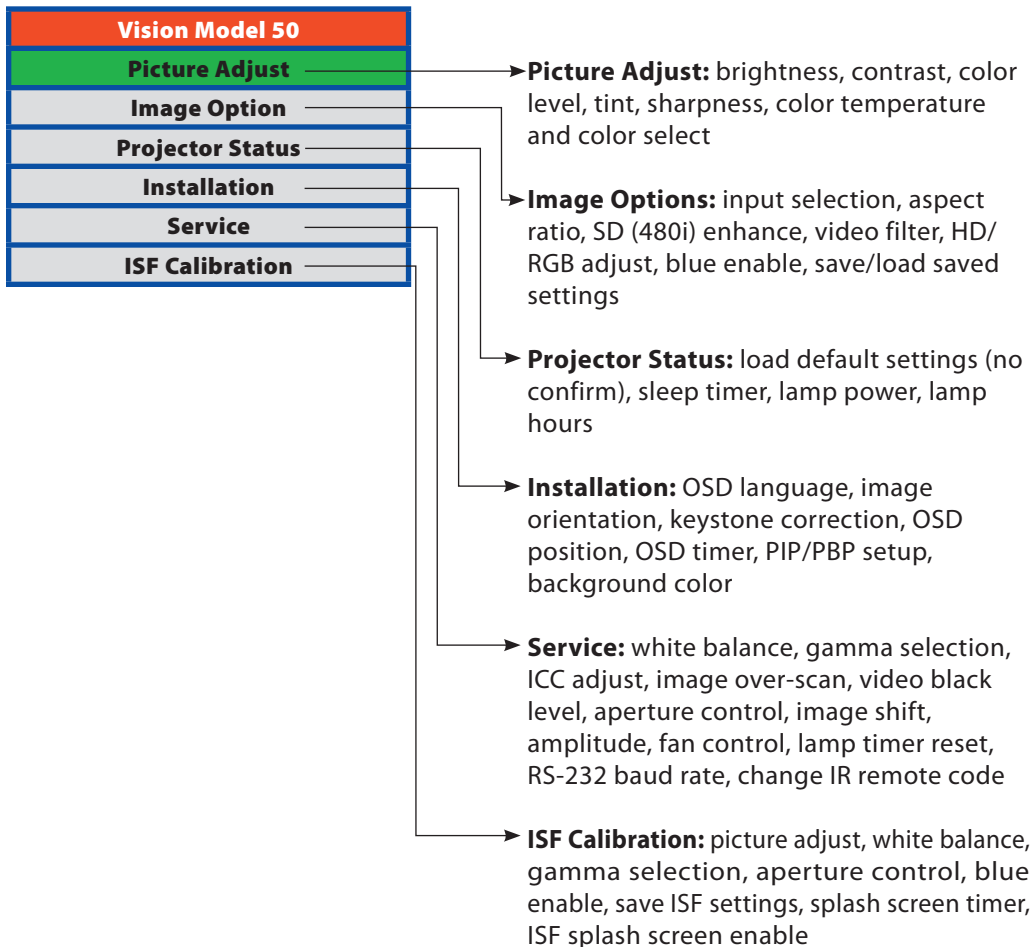

## Main Menu



## Picture Quality Adjustments

<b>Vision Model 50</b>	
<b>Picture Adjust</b>	→
Image Option	
Projector Status	
Installation	
Service	
ISF Calibration	

<b>Picture Adjust</b>	
Brightness	 26
Contrast	 15
Color	 31
Tint	 14
Sharpness	 2
Color Temp.	 2
Color Select	NTSC

To access basic picture quality adjustments, press **MENU**, select **Picture Adjust** and press **ENTER**. The picture quality sub-menu then appears (see above).

To adjust a setting, highlight it with the **▲** or **▼** button and use the **◀** or **▶** buttons to change the setting. When finished, press **EXIT**.

- Brightness** ➤ Select **Brightness** to adjust the black level of the projected image (0 = minimum; 60 = maximum).
- Contrast** ➤ Select **Contrast** to adjust the white level of the projected image (0 = minimum; 32 = maximum).
- Color** ➤ Select **Color** to adjust the color level (saturation) of the projected image (0 = minimum; 64 = maximum).
- Tint** ➤ Select **Tint** to adjust the hue of the projected image (0 = minimum; 30 = maximum).
- Sharpness** ➤ Select **Sharpness** to adjust the sharpness of the projected image (-14 = minimum; +20 = maximum). This setting has no effect if the Video Filter is set to 0 (refer to the next section, *Image Option*).

---

The Vision Model 50 has six memory settings for **Color Temperature**. Four of these settings are factory set to default as follows: **◀ Color Temperature**

- 0** -- Original lamp color temperature
- 1** -- 5400 kelvins
- 2** -- 6500 kelvins
- 3** -- 8500 kelvins
- 4** -- Custom
- 5** -- Custom

Custom 4 and 5 memory are installer-adjustable and can be used to create custom settings. There are nine adjustable “white balance” parameters available for the Custom 4 and 5 settings (three each for red, green and blue). These are described later in this section; refer to “Service.”

*NOTE: You must enter a passcode in order to enter the Service menu.*

Choose **Color Select** from the Picture Adjust menu to select the color space that is appropriate for the source signal, to achieve optimal color balance. **◀ Color Select**

If you select NTSC, HDTV or PAL, you can make further adjustments to individual color characteristics in the **ICC Adjust** sub-menu under the **Service** menu, described later in this section. (The Standard color select is factory-set and not adjustable.)

## Image Options

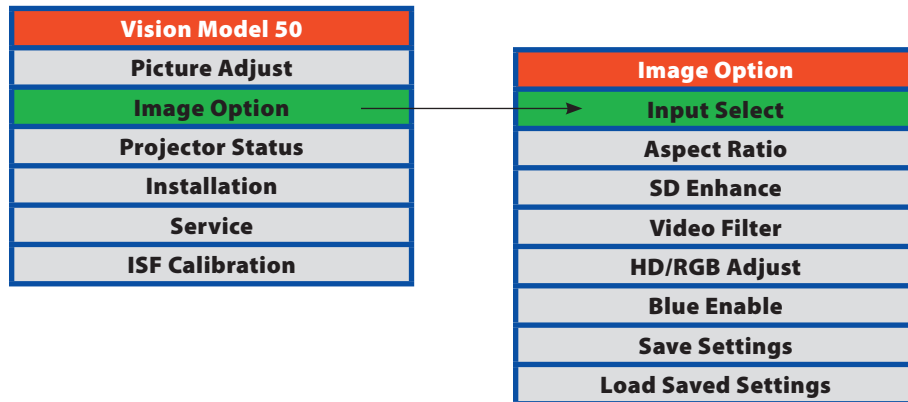

To access additional image settings, press **MENU**, then press the **▲** or **▼** arrows to highlight **Image Option** and press **ENTER**. The Image Option sub-menu then appears (see above).

- Input Select** ➤ To select a source signal, highlight **Input Select**, press **ENTER** and select Video, S-Video, Component 1, Component 2, RGB-HD or HDMI. Then, press **ENTER** to confirm.
- Aspect Ratio** ➤ To change the aspect ratio (size and shape) of the projected image, select **Aspect Ratio** from the Image Option menu and press **ENTER**. There are six aspect ratios available that can be selected for video signal inputs:

- **Anamorphic**

The image is compressed vertically, but anamorphic software will appear properly proportioned. This is best suited for use with 16:9 DVDs and HDTV programming.



- **Letterbox**

The image in the Letterbox mode is stretched vertically, and the top and bottom portion 'blanked off'. This ratio is best suited for LaserDisc movies or non-anamorphic DVDs.



- **Standard (4/3)**

The input signal is scaled to fit in the center of the 16:9 screen.



- **IntelliWide**

A 4:3 image is transformed into a 16x9 image.

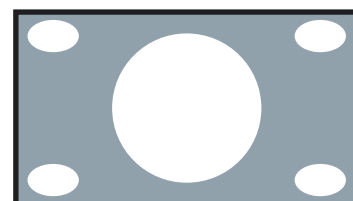

• **Cinema**

The image in the Letterbox mode is enlarged to a 16x9 image and the upper and lower portions are compressed.

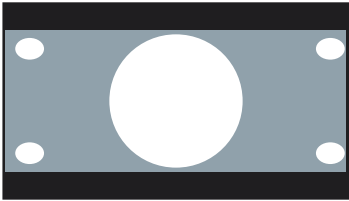

• **Cinema Fill**

A 2.35 image is stretched vertically in both directions to fill a 16:9 image.

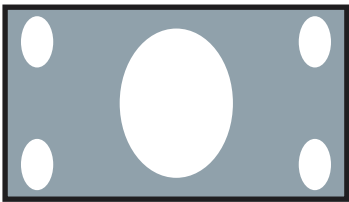

The SD Enhance menu gives you options for improving the quality of standard-definition, 480i images. (For 480p and higher-definition images, the controls in this menu are disabled.) Keep in mind that these controls add frequencies that are not present in the original signal, and may make images appear “noisy” if misused.

**H Enhance/V Enhance:** These controls can improve the apparent horizontal and/or vertical resolution of the image.

**C (Chroma) Enhance:** This control adds chroma (color information) to the input signal and can make colors appear more vibrant and saturated.

**H Threshold/V Threshold/C Threshold:** Set these to +11 or higher to activate the enhancement controls described above. Generally, the higher the threshold, the more noticeable the enhancements you make will be.

SD Enhance		
H Enhance	<input type="range" value="0"/>	0
V Enhance	<input type="range" value="0"/>	0
C Enhance	<input type="range" value="64"/>	64
H Threshold	<input type="range" value="10"/>	10
V Threshold	<input type="range" value="10"/>	10
C Threshold	<input type="range" value="10"/>	10

◀ **SD Enhance**

The **Video Filter** setting controls the behavior of the Sharpness control. The available settings depend on the vertical resolution of the input signal, as follows:

◀ **Video Filter**

- **With a 480i signal**, you can apply the sharpness control to either the input signal (1), the output signal (2), both (3) or neither (0).
- **With a 480p or higher-resolution signal**, the sharpness control is applied only to the output signal and only when you set the Sharpness filter to “on” (1).

**HD/RGB Adjust** ➤ Press **ENTER** to display the **HD/RGB Adjust** menu. Use these settings to fine-tune 480p and higher-resolution signals for optimum picture quality.

- **Auto:** To adjust the phase, frequency and position automatically, highlight "YES?" and press **ENTER**.
- **Freq.:** Adjusts the frequency of the signal.
- **Phase:** Adjusts the phase of the input signal (similar to tracking on a VCR).
- **H. Pos.:** Adjusts the horizontal position of the image.
- **V. Pos.:** Adjusts the vertical position of the image.

HD/RGB Adjust		
Auto Adj.	YES?	
Freq.		0
Phase		+10
H.Pos.		0
V.Pos.		0

*NOTE: To adjust the image position with a 480i source, use the **Image Shift** controls in the Service menu, described on page 41.*

**Blue Enable** ➤ Press the ▲ or ▼ arrow buttons to turn on or off the **Blue Enable** feature. Blue Enable removes all red and green color information from the image, and is useful for color-calibrating the projector or other video components.

**Save Settings** ➤ Once the desired adjustments have been made, select **Save Settings** to save these settings into the "Custom 1" memory location.

**Load Saved Settings** ➤ To recall stored custom image quality settings, select **Load Saved Settings** and choose "Custom 1," "ISF Night" or "ISF Day."

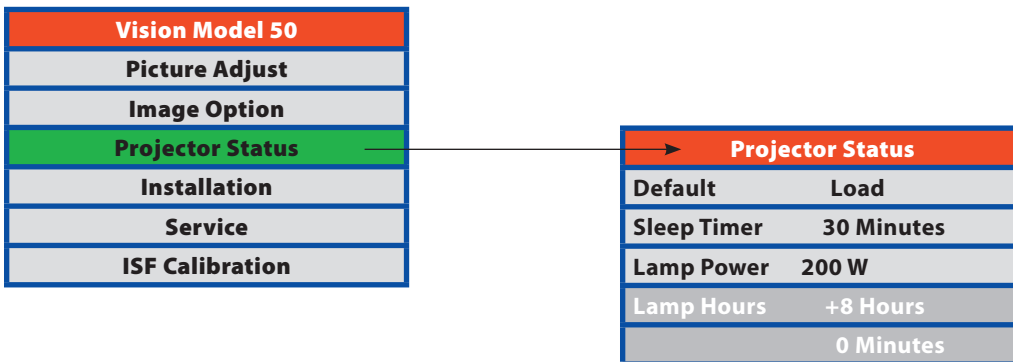

## Projector Status

To load default settings, configure the sleep timer or adjust the lamp, press **MENU**, then press the **▲** or **▼** arrows to highlight **Projector Status** and press **ENTER**. The Projector Status sub-menu will then appear (see above). Press **EXIT** to return to the previous menu or press **MENU** to close all menus.

To restore the default image settings for the current input source ONLY, press the **▲** or **▼** arrow buttons to highlight "Load," then press **ENTER**.

◀ **Default**

The Sleep Timer automatically puts the projector into standby mode after the amount of time you specify here. (A warning appears on-screen one minute before this is to occur.)

◀ **Sleep Timer**

Press the **◀** or **▶** arrows to set the timer for anywhere from 10 minutes to 3 hours, in 10-minute increments. To disable the Sleep Timer, set it to 0.

Select **Lamp Power** from the Set Up **MENU** to adjust the lamp output level. You can choose to run the lamp as bright as possible (250W; this is the default setting) or you can choose the lower (200W) setting. Generally, lower lamp output can prolong the life of the lamp, but decreases brightness.

◀ **Lamp Power**

**Lamp Hours** indicates how long the currently-installed lamp has been in service. (This part of the menu is read-only.)

◀ **Lamp Hours**

## Installation



To access the Installation menu, press **MENU**, then press the ▲ or ▼ arrows to highlight **Installation** and press **ENTER**. The Installation sub-menu will then appear (see above). Press **EXIT** to return to the previous menu or press **MENU** to close all menus.

*NOTE: When you change a setting in the Installation menu, the change takes effect immediately; you do not need to press **ENTER** afterwards. (Press **EXIT** to return to the previous menu or **MENU** to exit.)*

- Language** ▶ Press the ▲ or ▼ arrows to select from the available **Languages**: English, French, Spanish, German and Italian.
  
- Picture Configuration** ▶ Press the ▲ or ▼ arrows to select the projector's **Picture Configuration**. The projector can be installed on a ceiling or in a rear-screen configuration with one or more mirrors. There are four settings: Floor Front, Ceiling Front, Floor Rear and Ceiling Rear.
  
- Keystone** ▶ To correct distortion resulting from the angle of the projection, select **Keystone** and use the ◀ or ▶ arrows to make the image rectangular.
  
- NOTE: Vidikron recommends that the keystone feature not be used unless absolutely necessary, as it may cause artifacts in the image.*
  
- OSD Position** ▶ Press the ◀ or ▶ arrows to adjust the horizontal and vertical position of the OSD.
  
- OSD Timer** ▶ Press the ◀ or ▶ arrows to set the OSD Timer. This timer controls how long the menus remain on-screen after selecting them. Select from 0 to 60 seconds, in 3-second increments. When you set the OSD to 0, the menus remain on-screen until you hide them by pressing **MENU**.



To use the Picture-in-Picture or Picture-by-Picture features, press the ▲ or ▼ arrow buttons to select **PIP/PBP Setup**, then press **ENTER**.

◀ **PIP / PBP Setup**

Select **PIP/PBP Enable** from the **PIP/PBP Setup** menu. Press ▲ or ▼ to select **Off** or **On**, then press **EXIT**.

◀ **PIP/PBP Enable**

<b>PIP/PBP Setup</b>
<b>PIP/PBP Enable</b>
<b>PIP Setup</b>
<b>PBP Setup</b>

Press the ▲ or ▼ arrows to select **PIP Setup**, then press **ENTER**. Press the ▲ or ▼ arrows to select **PIP Off**, **Graphic in Video** or **Video in Graphic**, then press **ENTER**.

◀ **PIP Setup**

Press the ▲ or ▼ arrows to select **PBP Setup**, then press **ENTER**. Press the ▲ or ▼ arrows to select **PBP Off**, **Graphic by Video** or **Video by Graphic**, then press **ENTER**. Press **EXIT** to return to the **Installation** menu.

◀ **PBP Setup**

Press the ▲ or ▼ arrows to select the image **Background Color** (grey, blue or white). The Background Color appears when no incoming signal is present.

◀ **Background Color**

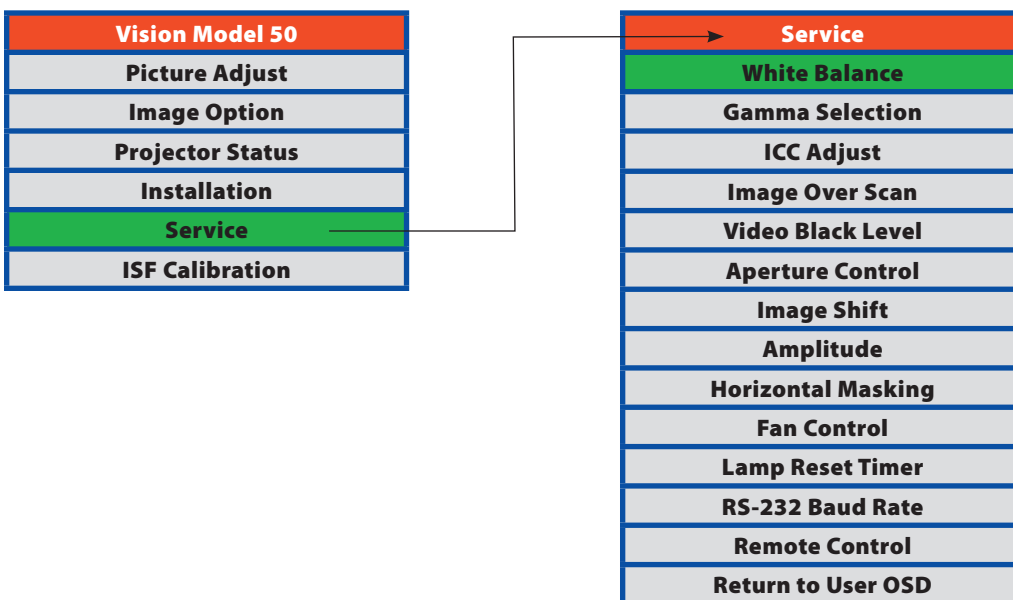

---

## Service

To access advanced picture quality adjustments and projector controls, use the up- or down-arrow buttons to highlight **Service** and press **ENTER**. Use the number buttons on the remote to enter the Service menu passcode when prompted and press **ENTER** again. Then, press **MENU** on the remote control.

*NOTE: You only need to enter the Service menu passcode the first time you select that menu after turning on the projector.*

**White Balance** ➤ **Gain:** Use the Gain controls in the White Balance sub-menu to correct color imbalances in the bright areas of the image. A good way to do this is to use a test pattern consisting mostly of solid white areas, such as an 80 IRE “window” pattern. If the white areas contain traces of red, green or blue, decrease the Gain for that color.

**Offset:** Use the Offset controls in the White Balance sub-menu to correct color imbalances in the dark areas of the image. A good way to do this is to use a test pattern consisting mostly of dark gray areas, such as a 30 IRE “window” pattern. If the gray areas contain traces of red, green or blue, decrease the Offset for that color.

**Gamma:** “Gamma” is a global setting that determines how gray shades are displayed between minimum input (black) and maximum input (white) for all signals. A good gamma setting helps to optimize blacks and whites while ensuring smooth transitions for the “in-between” values utilized in other grays. Unlike “Brightness” and “Contrast” controls, the overall tone of your images can be lightened or darkened without changing the extremes and all images will be more vibrant while still showing good detail in dark areas when using the “Gamma” control.

In all but the most unusual situations, the appropriate “Gamma Selection” (see below) will produce accurate colors and a satisfying contrast level. However, it is sometimes necessary to adjust the red, blue and green gamma curves individually. To do this, select Gamma from the White Balance sub-menu and use the left- and right-arrow buttons to manipulate the on-screen slidebars.

**Save Color Temp.4/Save Color Temp.5:** When you are finished adjusting the Gamma, Gain and Offset, select Save Color Temp.4 or Save Color Temp.5 to store your settings. To recall them, set the Color Temperature to +4 or +5 in the Picture Adjust menu (refer to “Picture Quality Adjustments,” earlier in this section).

**Gamma Selection** ➤ The default gamma setting of 2.2 is correct for almost all signals and conditions. If excess ambient light washes out the image and it becomes difficult or impossible to see details in dark areas, lower the gamma setting to compensate. This will improve contrast while maintaining good details for blacks. Conversely, if the image is washed out and unnatural, with excessive detail in black areas, increase the setting. Again, good gamma improves contrast while maintaining good details for blacks and whites.

**ICC Adjust** ➤ Use the ICC Adjust controls to customize the stored NTSC, HDTV and/or PAL color select characteristics. To do this, select the color select to modify. Then, select a component color (Red, Green, Blue, Yellow, Cyan or Magenta).

For each component color, you can adjust the following:

**Intensity:** This slidebar adjusts the intensity -- also known as *luminance* -- of a given color.

**Sat.:** This slidebar adjusts the color saturation level -- the *amount* of that color in a video image. Lower settings produce less saturated colors; a setting of “0” removes that color from the image entirely. If the saturation is too high, that color will be overpowering and unrealistic.

**Hue:** This slidebar adjusts the red/green color hue for true color reproduction of video signals. For best results, adjust tint while displaying an external color bars test pattern. Otherwise, it is recommended that Hue remain at its default setting.

When you have finished customizing the color select, select **Store Setting** and press **ENTER**.

Image Over Scan pushes the outside edge of the active picture area of the video signal out beyond the edge of the display area.

#### ◀ **Image Over Scan**

Some television programs are produced based on the assumption that older television sets may not display the outer edges of the broadcast picture area. Over scan effectively trims away these inactive, outer edges and enlarges the remaining portion of the image to fill the display area.

Use the on-screen slider to set the desired amount of over scan.

For HDTV, DVDs and other video sources, Over Scan is generally not necessary or desirable.

This control compensates for incoming elevated black levels present in certain video signals, and ensures that blacks in the display are neither “crushed” (where dark grays appear black) nor excessively elevated (where blacks appear dark gray). By default, the projector automatically determines the best setting according to the type of incoming video signal:

#### ◀ **Video Black Level**

- 0 IRE – Used for DVD output with “enhanced black,” SECAM, most PAL standards and Japanese NTSC.
- 7.5 IRE – Used for most NTSC video signals.

For some types of video, you may want to override the setting. Generally, if black appears crushed when brightness = 30, choose “0 IRE”. If black appears excessively elevated, use “7.5 IRE”.

The Aperture Control lets you control the motorized aperture lens iris. Press the ► arrow to raise contrast and decrease brightness; press the ◀ arrow to lower contrast and increase brightness.

#### ◀ **Aperture Control**

The contrast ratio is the measurement of the difference between the brightest whites and the darkest blacks a display can show. The Aperture Control lets you adjust the contrast level to allow for ambient lighting levels within a room which may affect color detail.

The Image Shift menu allows you to precisely center the image on the screen. (These controls are available only with a 480i source signal.)

#### ◀ **Image Shift**

**Horizontal:** This control moves the image right or left within the area of available pixels.

**Vertical:** This option moves the image up or down within the area of available pixels.

#### NOTES:

1. To adjust the image position with a 480p or higher-resolution source, use the **HD/RGB Adjust** controls in the Image Option menu, described on page 36.
2. The values shown represent where the approximate center of the image lies in relation to the total number of pixels available horizontally or vertically. This varies widely according to the signal; watch the image while adjusting.

The Amplitude menu allows you to fine-tune the image aspect ratio by stretching it horizontally or vertically, in small increments. The **Horizontal** control adjusts the image width while keeping the height constant. Similarly, the **Vertical** control adjusts the image height while keeping the width constant.

#### ◀ **Amplitude**

This menu item is reserved for future use.

#### ◀ **Horizontal Masking**

**Fan Control** ➤ Select **Fan Control** from the Service Menu to control the operation of the projector's cooling fan.

**Mode:** In most cases, the default Fan Control Mode (Auto Normal) will maintain the correct operating temperature. If the lamp frequently turns off due to overheating, or in certain high-altitude operating environments, you may need to change this setting to **Auto Hi. Altitude** or **Manual**.

**Fan Speed:** If you set the Fan Mode to Manual, select **Fan Speed** and use the on-screen sidebar to adjust the speed.

After changing either of these settings, press **EXIT** to return to the previous menu.

**Lamp Reset Timer** ➤ When you replace the projector lamp, you should also reset the lamp timer. To do this, select **Lamp Reset Timer** from the Set Up menu. Press the right-arrow button on the remote to highlight "Yes," then press **ENTER** to confirm the reset.

*NOTE: Reset the Lamp Timer ONLY after you replace the lamp. Otherwise, the reported "Lamp Hours" will be inaccurate.*

**WARNING! Do not exceed the recommended lamp life of 2000 hours. An old lamp becomes increasingly fragile and prone to sudden failure.**

**RS-232 Baud Rate** ➤ Press the ▲ or ▼ arrows to select the projector's **RS-232 Baud Rate**. This function is used to change the transfer rate of the RS-232 connection. (This setting must match the data rate of the device connected to the RS-232 input.)

**Remote Control** ➤ The Remote Control menu shows you the primary and secondary infrared (IR) codes assigned to the Vision Model 50. The Primary IR code is permanently set to +20. The secondary IR code is also +20.

You can change the secondary IR code if either:

- Another device in the theater (a DVD player, for example) is responding to commands from the Model 50 remote control in ways that are unpredictable or undesirable.
- You have multiple Model 50 projectors and want to control them independently, as opposed to broadcasting commands from a single remote to all of them. In this scenario, you can use multiple remotes programmed to use different IR codes. Or, you can use a single remote and change the IR code as needed to address a specific projector.

When you change the secondary IR code, the remote sends that code instead of the primary IR code.

*NOTE: The Remote Control menu is read-only and need not be visible in order to change the secondary IR code.*

To simultaneously change the secondary IR code and synchronize that remote with a projector, *point the remote at the projector*, then press and hold ◀ and ▶ simultaneously for five seconds. The Remote Control edit window, shown at right, appears. Type a new, two-digit code.



The procedure for changing the secondary IR code on the remote *only* is the same, except that you point the remote away from the projector.

**Return to User OSD** ➤ To exit the Service menu, use the up- or down-arrow buttons to highlight **Return to User OSD** and press **ENTER**.

To return to the Service menu, select it from the Main Menu, press **ENTER** twice, then press MENU on the remote control. (You do not need to re-enter the passcode.)

The Vision Model 50 has been designed to incorporate setup and calibration standards established by the Imaging Science Foundation (ISF). The ISF has developed carefully crafted, industry-recognized standards for optimal video performance and has implemented a training program for technicians and installers to use these standards to obtain optimal picture quality from Vidikron video display devices. Accordingly, Vidikron recommends that setup and calibration be performed by an ISF certified installation technician.

All signal types require separate processing. Therefore, you need to calibrate each and every input separately.

To access the ISF Calibration menu, use the up- or down-arrow buttons to highlight **ISF Calibration** and press **ENTER**. Use the number buttons on the remote control to enter the ISF Calibration menu passcode, then press **ENTER** again.

*NOTE: You only need to enter the ISF Calibration menu passcode the first time you select that menu after turning on the projector.*

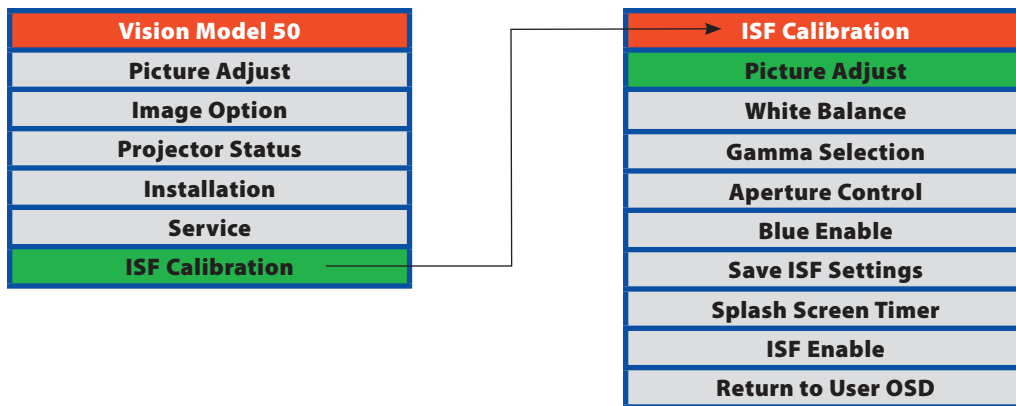

## ISF Calibration

These settings are described in the "Picture Quality Adjustments" section (refer to page 34).

← **Picture Adjust**

These settings are described in the previous section, "Service."

← **White Balance**

These settings are described in the previous section, "Service."

← **Gamma Selection**

This setting is described in the previous section, "Service."

← **Aperture Control**

This setting is described in the "Image Options" section (refer to page 36).

← **Blue Enable**

When you have finished calibration, select **Save ISF Settings** and choose "Save ISF Night" or "Save ISF Day" to store your settings.

← **Save ISF Settings**

To recall stored custom image quality settings, select **Load Saved Settings** from the Image Option menu (refer to "Image Options," earlier in this section) and choose "Custom 1," "ISF Night" or "ISF Day." Or, simply use the corresponding buttons on the remote control (**MEM1**, **ISF NT** and **ISF DAY** respectively).

- Splash Screen Timer** ➤ Press the ◀ or ▶ arrows to set the Splash Screen Timer. This timer controls how long the startup (ISF and Vidikron logo) image stays on-screen after you turn on the projector. Select from 5 to 60 seconds, in 1-second increments. When finished, press **EXIT**.
  
- ISF Enable** ➤ Use **ISF Enable** to control the display of the ISF logo on the Vision 50 splash screen upon power-up.



## Lamp Replacement

The lamp should be replaced when it reaches the end of its life (typically 2000 hours), or sooner if a noticeable degradation in brightness occurs.

1. Turn off the projector and unplug the power cord. Allow the projector to cool down for approximately 45 minutes prior to removing the lamp assembly for replacement.

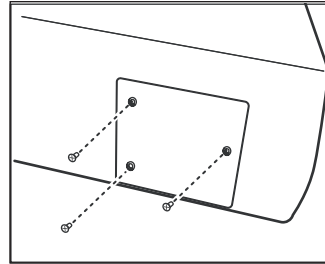

2. Remove the three screws from the lamp cover.

3. Remove the lamp cover.

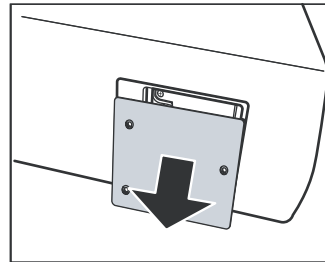

4. Remove the two screws from the lamp module.

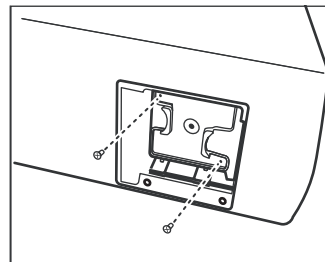

5. Pull the lamp module straight out to remove it.

6. Insert the new lamp module securely and replace the two screws.

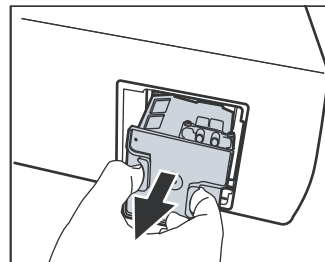

7. Replace the lamp cover at the top side first as shown and secure it with the three screws.

8. Turn on the power and go into the Service/Reset Lamp Timer menu to reset the lamp timer. Refer to "Service" in the previous section, *On-Screen Display Menus*.

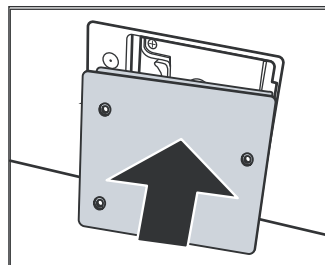

This page is intentionally left blank.



PROBLEM	POSSIBLE CAUSE	REMEDY
<b>The projector does not turn on</b>	There is no power from the power cable.	Plug the power cord into the AC power socket on the rear of the projector and an electrical outlet.
	The power switch is not turned on.	Turn on the power switch.
	The projector was turned on again within the cool down time.	Wait until projector completes the cool down time.
	Lamp cover is not attached well.	Correctly attach the lamp cover.
<b>No picture</b>	The lamp cover is not correctly attached.	Correctly attach the lamp cover.
	The projector is not correctly connected to the input source device.	Check the connection.
	The input signal has not been correctly selected.	Select the correct input signal with the SOURCE input keys: VID, S-VID, COMP1, COMP2, RGBHD or HDMI.
	TEMP LED or LAMP LED blinking.	Please contact your Vidikron dealer for assistance.
<b>Image is unstable</b>	The connection cables are not connected to the projector.	Correctly connect the cables to the appropriate terminals.
<b>Picture is blurred</b>	The projection lens is not correctly focused.	Adjust the focus of the projection lens with the focus ring.
	The projector and the screen are not aligned squarely.	Adjust the projection angle and direction, and the height of the projector.
<b>Remote control does not work correctly</b>	The batteries are exhausted.	Replace both batteries with new ones.
<b>LAMP LED blinks red</b>	The cooling fan does not work well.	Please contact your Vidikron dealer for assistance.
	The temperature inside the projector is extremely high.	Check that the ventilation holes are not blocked.
<b>LAMP LED blinks red; POWER LED is green</b>	The lamp has exceed its specified usage hours.	Replace the lamp with a new one.
	The lamp has burned out.	Replace the lamp with a new one.

This page is intentionally left blank.

1. Connect a D-Sub 9-pin female-to-RJ-11 adapter (not included) to a COM port on your PC. The adapter must be wired as follows:

RS-232 Pin Assignments		
D-Sub 9-pin female	4-pin RJ-11	Function
2	2	Transmit Data
3	3	Receive Data
5	1, 4	Ground
1, 4, 6, 7, 8, 9	--	Not Connected

## Connecting RS-232 to the Projector

2. Connect the COM port to the RS-232 port on the projector. Use a standard, 4-wire RJ-11 telephone cable, wired straight-through.

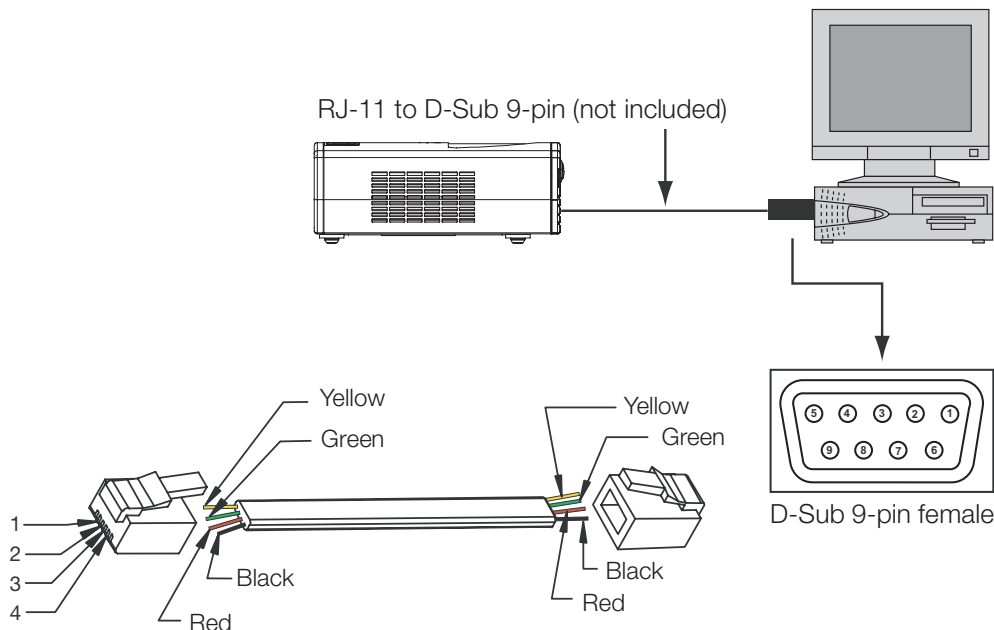

3. Start a terminal session on your PC using a terminal-emulation program, such as HyperTerminal.
4. Configure the COM port on the PC as follows: no parity, 8 data bits, 1 stop bit and no flow control. Set the baud rate to match that of the projector (115200, 38400 or 9600).
5. Press **ENTER**. You should see a command prompt (>) in the terminal window.
6. Type the desired command from the table that follows and press **ENTER**. For example, to set the aspect ratio to Letterbox, type **x063x <Enter>**.

## RS-232C Control Codes

### NOTES:

1. All codes are in the ASCII format.
2. A carriage return is required after each command.
3. The projector will not accept RS-232 commands for 20 seconds after it is turned on or off.

Code	Function	Code	Function
x001x	Power On	x049x	Load default of current source
x002x	Power Off	x051x	Single source, full-screen
x003x	Menu	x052x	PIP - graphics on video
x004x	Enter	x053x	PIP - video on graphics
x005x	Exit	x054x	PBP - graphics by video
x006x	Up (arrow button)	x055x	PBP - video by graphics
x007x	Down (arrow button)	x056x	PIP - increase sub-window size
x008x	Left (arrow button)	x057x	PIP - decrease sub-window size
x009x	Right (arrow button)	x058x	Set PIP/PBP active window
x011x	Show active source and aspect ratio information	x061x	Anamorphic (16:9) aspect ratio
x021x	Keypad 1	x062x	Standard (4:3) aspect ratio
x022x	Keypad 2	x063x	Letterbox aspect ratio
x023x	Keypad 3	x064x	IntelliWide aspect ratio
x024x	Keypad 4	x065x	Cinema aspect ratio
x025x	Keypad 5	x066x	Cinema Fill aspect ratio
x026x	Keypad 6	x071x	RS-232 baud rate = 9600
x027x	Keypad 7	x072x	RS-232 baud rate = 38400
x028x	Keypad 8	x073x	RS-232 baud rate = 115200
x029x	Keypad 9	x081x	Image orientation = floor front
x030x	Keypad 0	x082x	Image orientation = ceiling front
x031x	Store image settings to Memory 1	x083x	Image orientation = floor rear
x032x	Store image settings to ISF Night	x084x	Image orientation = ceiling rear
x033x	Store image settings to ISF Day	x091x	Lamp Power = 200W
x046x	Restore image settings from Memory 1	x092x	Lamp Power = 250W
x047x	Restore image settings from ISF Night	x121x	OSD Language = English
x048x	Restore image settings from ISF Day	x122x	OSD Language = French
		x123x	OSD Language = Spanish
		x124x	OSD Language = German
		x125x	OSD Language = Italian

<b>Code</b>	<b>Function</b>
x131x	Switch to Composite input
x132x	Switch to S-Video input
x133x	Switch to RGB-HD input
x134x	Switch to DVI input (HDMI)
x135x	Switch to Component 1 input
x136x	Switch to Component 2 input
x156x	Background Color = Grey
x157x	Background Color = Blue
x158x	Background Color = White
x181x	Toggle Blue Image on/off
x281x	Vertical Lens Shift = Up
x282x	Vertical Lens Shift = Down
x283x	Zoom In
x284x	Zoom Out
x285x	Focus (rotate lens to right)
x286x	Focus (rotate lens to left)
x287x	VAC = Full On (open)
x288x	VAC = Full Off (closed)

---

## **RS-232C Control Codes (continued)**

This page is intentionally left blank.

## Specifications

<b>Projector Type:</b>	Digital Light Processing™ (DLP™), Single-Chip DMD™
<b>Native Resolution:</b>	1280 x 720 (16:9)
<b>Aspect Ratios:</b>	4:3, Letterbox, 16:9 Anamorphic, IntelliWide™, Cinema, CinemaFill™
<b>Video Standards:</b>	NTSC, PAL, SECAM
<b>DTV Compatibility:</b>	480p, 576p, 720p, 1080i
<b>Scan Frequency:</b>	Horizontal: 15-80 kHz; Vertical: 50-100 Hz
<b>Picture Size (16:9 screens):</b>	Recommended Width: 72 in. (1.83 m) to 96 in. (2.44 m) Capable of screen widths between 48 in. (1.22 m) and 240 in. (6.10 m)
<b>Throw Distance (Factor x Screen Width):</b>	1.82 to 2.42 x Screen Width
<b>Horizontal and Vertical Offset:</b>	<ul style="list-style-type: none"><li>- Lens is fixed horizontally</li><li>- Lens can shift vertically 100% up or down</li><li>- Horizontal and/or vertical image shift via OSD controls</li></ul>
<b>Lamp:</b>	250W
<b>Lamp Life:</b>	2000 hours
<b>Inputs:</b>	(1) Composite Video, (1) S-Video, (1) RGB/Component (via BNC), (1) RCA Component Video, (1) HDMI, (1) RS-232
<b>12V Output:</b>	Max. 0.25 Amps, active when the projector is on

**Brightness and Contrast:**

- Cinema Standards Measurement System (CSMS) Specifications
- Brightness: 14.7 to 21.5 foot-Lamberts (fL)
  - Contrast Ratio: 195:1 to 218:1

These measurements are taken from the projector in a controlled, home theater environment. All measurements are made to ANSI/NAPM IT7.228-1997 specifications using the Photo Research PR-650 SpectraColorimeter and Minolta LS-100 Luminance Meter, Video Essentials test DVD and a 1.3 gain, 72-inch wide screen. The projector is calibrated to a color temperature of 6,500K and has a minimum of 150 hours of usage.

The foot-Lambert (fL) is the unit of measurement used in commercial movie theaters to express image brightness at the screen surface. The Society of Motion Picture and Television Engineers (SMPTE) specifies 16 fL as the target image brightness for film-based projectors using an open gate (without film in the projector). More importantly, today SMPTE specifies 12 fL as the target image brightness in Digital Cinema theaters. The foot-Lambert measurement is dependent on screen size, screen gain and projector light output.

**Home Theater Calibration Specifications**

- Light Output: 449 to 585 ANSI Lumens
- Contrast Ratio: 195:1 to 218:1

These specifications are obtained by calibrating the projector as described above for CSMS measurements.

**Industry-Standard Specifications**

- Light Output: 1225 ANSI Lumens
- Contrast Ratio: 1400:1 to 3000:1

These are typical projector brightness and contrast specifications found in most companies' sales literature. Vidikron includes these measurements in its literature to allow for direct comparison with other manufacturers' projectors. These measurements are typically taken at 9,000K to 13,000K to get expected performance data when the projector is used in professional, commercial and industrial displays.

<b>Power Requirements:</b>	100 to 240V AC, 50/60Hz, 330W
<b>Operating Environment:</b>	41°F to 95°F (5°C to 35°C); 20 to 80% humidity (non-condensing)
<b>Dimensions:</b>	Width: 22.00 in. (560.5 mm) Depth: 18.90 in. (480.0 mm) Height (without feet): 8.00 in. (203.0 mm) Height (with feet): 8.80 in. (222.5 mm)
<b>Weight (including lens):</b>	Net: 43.0 lbs. (19.5 kg); Shipping: 55.1 lbs. (25.0 kg)
<b>Regulatory Approvals:</b>	Complies with FCC Class B, CE, C-Tick
<b>Limited Warranty:</b>	Projector: Two (2) years parts and labor from the date of delivery to the end user. Lamp Warranty: 1000 hours or six (6) months, whichever comes first.

Specifications are subject to change without notice.



# Dimensions

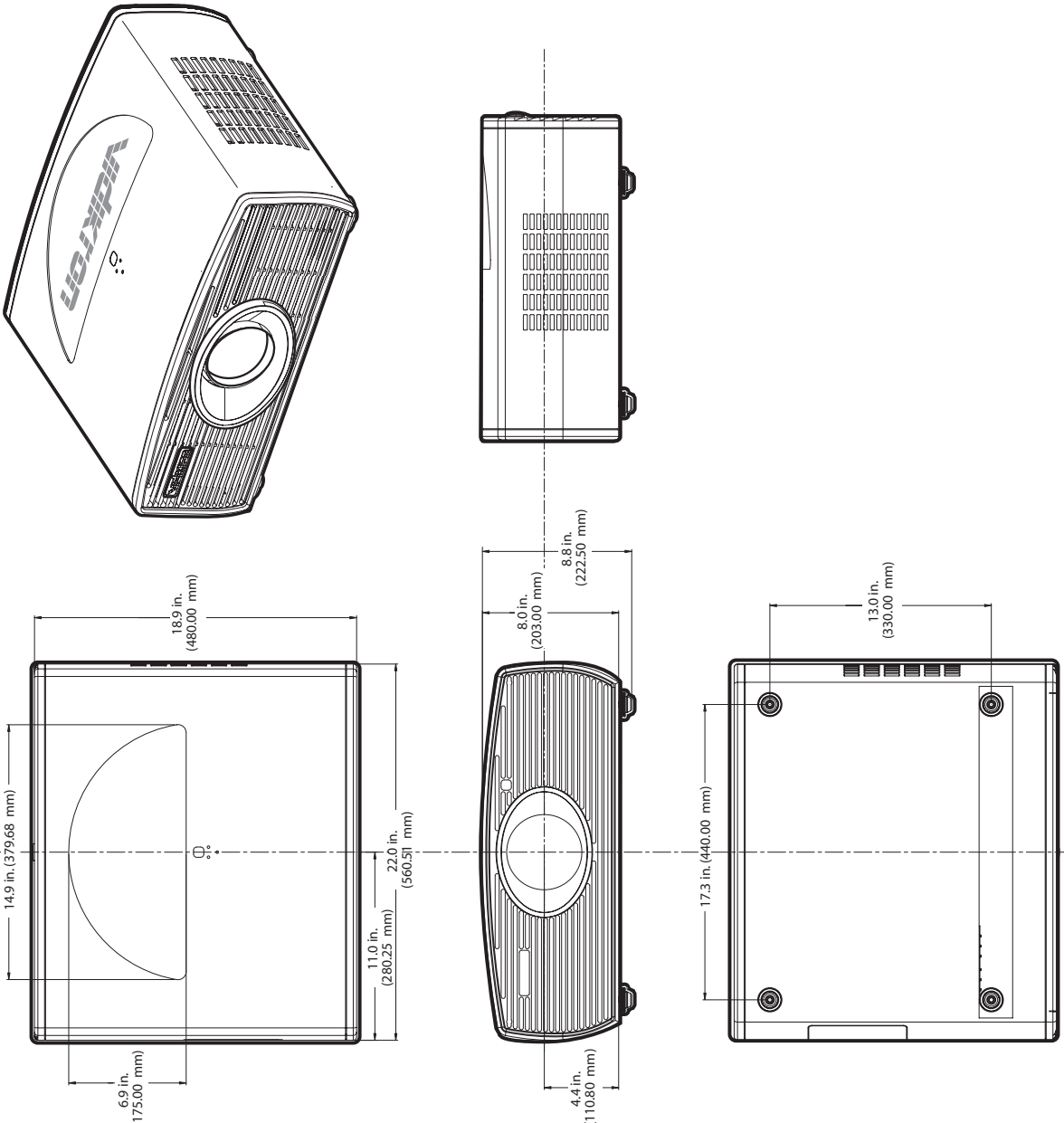

RUMA-011145  
rev. 09-27-05 v1.0



Vidikron  
2900 Faber Street  
Union City, CA 94587  
510-324-5900  
Fax 510-324-5905  
1-888-4-VIDIKRON  
[www.vidikron.com](http://www.vidikron.com)



SERIAL NUMBER

